

DESIGNER RAILS & LADDERS

FIVE FLAT BAR HEATED TOWEL LADDER

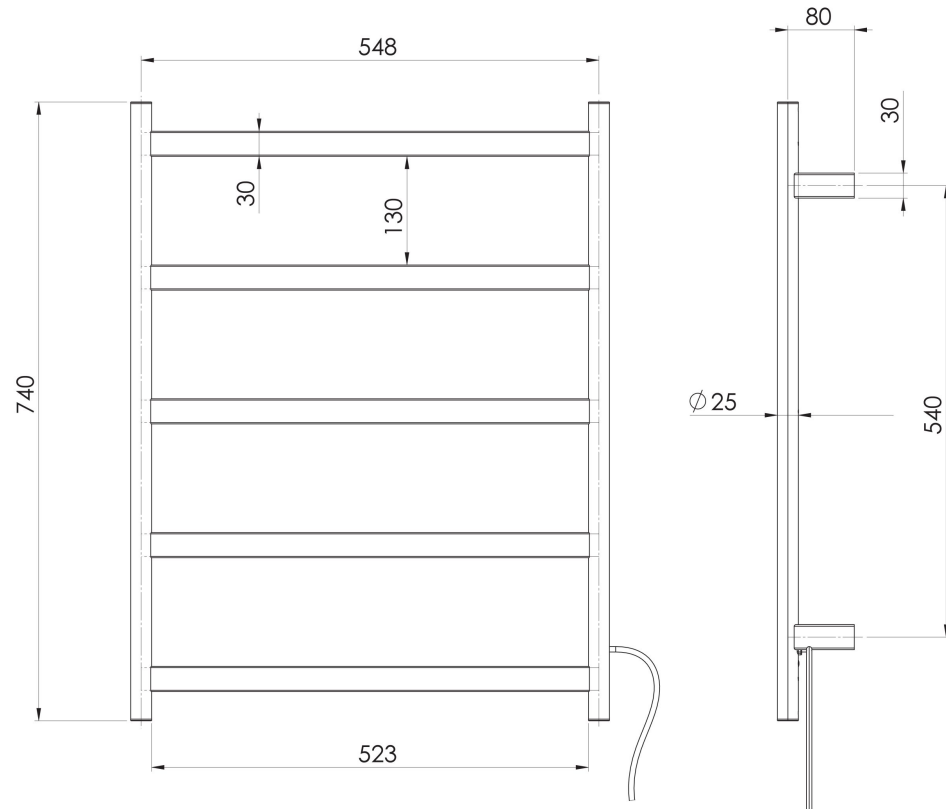

SPECIFICATIONS



AVAILABLE IN



652-8750-00
Chrome



652-8750-40
Brushed Nickel



652-8750-31
Brushed Carbon



652-8750-10
Matte Black



652-8750-12
Brushed Gold

INFORMATION



MAINTENANCE AND CARE:

- All surfaces should be cleaned with mild liquid detergent or soap and water.
- Do not use cream cleaners or citrus based cleaning products, as they are abrasive.
- Use of unsuitable cleaning agents may damage the surface.
- Any damage caused in this way will not be covered by warranty.

Electricity Input: 240V, 50Hz | Power Rating: 35W | IP Rating: IPX4 | Connection position: Bottom right |
Connection type: Plug-in or Hardwire

Please visit <https://www.phoenixtapware.com.au/warranty> to view the full warranty



While we aim to ensure the specifications shown are correct at time of printing, Phoenix Tapware reserves the right to make modifications without prior notice. Always use the physical product measurements for mark-ups and roughing-in as the line drawing shown may differ from the actual product over time. All measurements are shown in millimetres. Colours may vary from image shown.

Ph: +61 3 9780 4200
05/01/2024
phoenixtapware.com.au